

The advertisement features a vibrant blue sky with white clouds as a background. Several blue plastic tubes and various fittings are scattered across the scene. The tubes are arranged in parallel lines, creating a sense of depth. The fittings include elbows, tees, and straight connectors. The text 'TUBES AND FITTINGS FOR COMPRESSED AIR' is prominently displayed in the upper half, and the 'Sico AIR' logo is centered below it.

**TUBES AND FITTINGS
FOR COMPRESSED AIR**

Sico AIR



ALUMINIUM TUBES FOR COMPRESSED AIR

PRIMARY ALUMINIUM EXTRUDED TUBES EN AW-6060 T66 (AL Mg Si 0.5 F22)
ELECTROSTATIC PAINTING RAL 5015

CHEMICAL COMPOSITION									
ALLOY	Cu	Fe	Mn	Mg	Si	Zn	Cr	Ti	Al
6060	0.10	0.10-0.30	0.10	0.35-0.6	0.3-0.6	0.15	0.05	0.10	Rest

Specific weight 2.70 (Kg/m³) x 10³

MINIMUM MECHANICAL SPECIFICATIONS				
ALLOY	Ultimate tensile stress	Yield point	A5% Stretch	HB Hardness
6060	215 Rm N/mm ²	160 Rp 0.2 N/mm ²	8	75

ELASTIC MODULUS 69.000 Nm²
ELECTRIC RESISTIVITY 0.033 OMm²
THERMAL CONDUCTIVITY 210 W/mk
MELTING TEMPERATURE 615° C-655° C

EXPANSIVITY 20÷100°Cx10⁻⁶/°C
INTERNAL CHROMATIZING
CALIBRATED EXTRUSION

COMPRESSED AIR DISTRIBUTION



Sicomat
Sicomat[®]

COMPRESSED AIR

SPECIFICATIONS

TUBES

- Material:
EN AW-6060 T6 ALUMINIUM
- Treatment:
INTERNAL AND EXTERNAL CHROMATIZING
- Paint:
RAL 5015 ELECTROSTATIC PAINTING
- Use:
COMPRESSED AIR DISTRIBUTION - VACUUM -
NEUTRAL GASES
- Tube length:
4 m (standard) - 6 m (on demand)
- Tube quality:
CALIBRATED EXTRUSION
- Temperature:
from -20°C to +80°C
- Pressure:
from -0.6 to +15 BAR
- Compatible fluids:
COMPRESSED AIR - VACUUM - NEUTRAL GASES -
WATER

FITTINGS

- Body:
BLACK NYLON
- Coupling ring:
BLUE NYLON
- Cutting ring:
AISI 301 STAINLESS STEEL
- Sealing:
NBR O-RING
- Temperature:
from -20°C to +70°C
- Pressure:
from -0.6 to +13 BAR
- Compatible fluids:
COMPRESSED AIR - VACUUM - NEUTRAL GASES -
WATER

THE SYSTEM

- EASY AND RAPID TO INSTALL
- REDUCED PRESSURE DROP
- CORROSION RESISTANCE
- REUSABLE
- FIRE-RESISTANCE
- UV-RESISTANT
- GOOD SHOCK RESISTANCE
- NO WELDING
- MODERN DESIGN

R DISTRIBUTION

ASSEMBLY

CUTTING

Use a tube-cutter to obtain a clean cut.



CHAMFERING

Chamfer the external part of the tube in order not to damage the sealing ring.



ASSEMBLYING

Insert the tube and push it until it is completely home.



TIGHTENING

Tighten the coupling ring by hand or use the relevant tool.



Size	7 bar delivery	Code
Ø20 x 17	1.477 L/min.	059020017
Ø25 x 22	2.727 L/min.	059025022
Ø32 x 29	5.504 L/min.	059032029
Ø40 x 37	10.054 L/min.	059040037
Ø50 x 46	16.538 L/min.	059050046
Ø63 x 59	30.214 L/min.	059063059

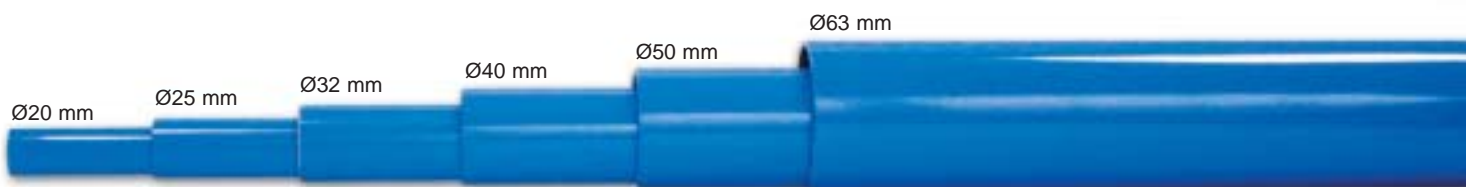

R-RANGE FITTING SIZES DN 20 - 25 - 32 - 40 - 50 - 63

WARNING:

to avoid seal damage chamfer tube ends before inserting them into the fittings.

1. Check that all the parts in the fitting are correctly mounted. (See Table A)

Table A

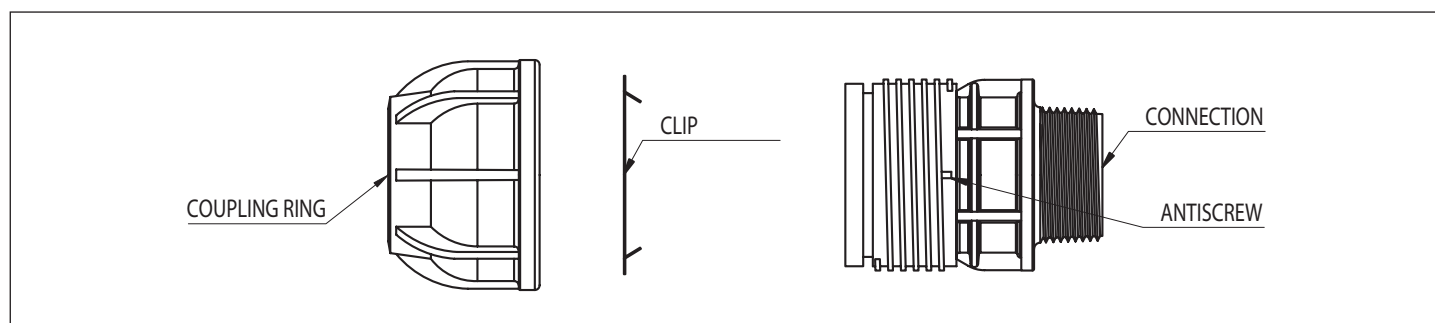

2. Before inserting the tube into the fitting rotate the light-blue coupling ring against the antiscrew tooth and no further.

3. The tube must be inserted into the fitting until tube bottoms inside. This can be checked by previously marking on the tube the length «L» indicated in the table here below. (See Table B)

Table B

DN	20	25	32	40	50	63
N/m	9 ÷ 11	11 ÷ 13	12 ÷ 15	15 ÷ 17	17 ÷ 20	18 ÷ 22
L = mm	45	55	60	70	85	95

4. Once the tube has been correctly inserted into the fitting, rotate the coupling ring completely over the antiscrew tooth. To easily carry out this operation it is advisable to use the tools indicated in the present catalogue.

5. Table B illustrates the tightening force needed for every fitting size (N/m) in order to guarantee optimal pneumatic and mechanical sealing results.

6. Table C illustrates the correct installation. Misalignment of more than 10° from the horizontal line may compromise the pneumatic tightness of the fittings.

Table C

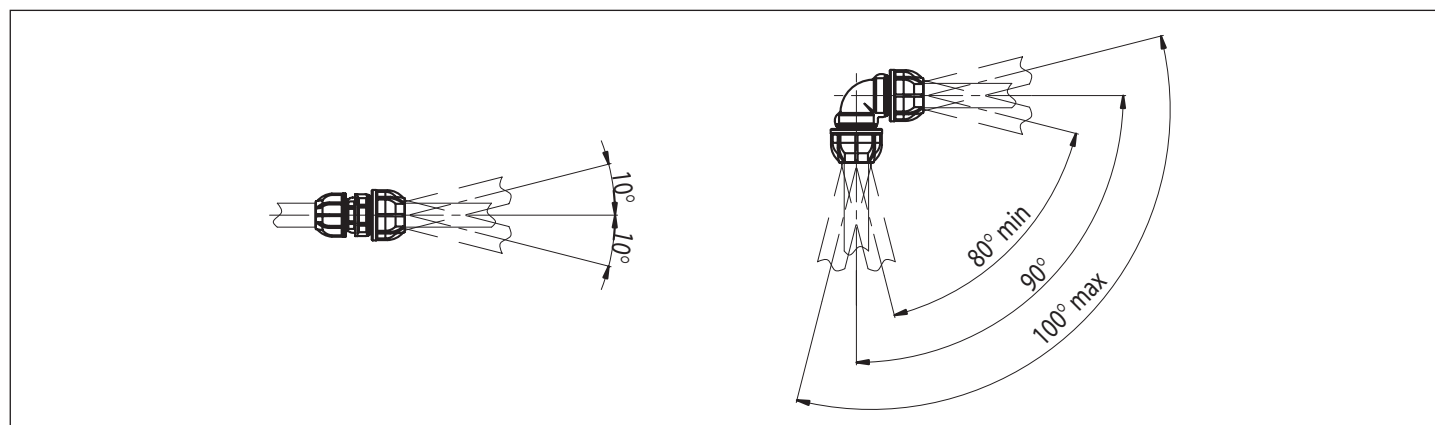

7. Carefully refer to the specifications indicated in the present catalogue as to compatibility with chemical substances that could be present in the pipes.

8. Sicomat will not be responsible for any damage caused by improper use of their products and/or non-compliance with the instructions indicated in the present catalogue.

2.1 Allowed air delivery

High quality internal surfaces enable to achieve air deliveries higher than those performed by iron tubes of the same sizes.

Table D indicates theoretical air delivery data in l/min. (standard reference atmosphere) calculated at a temperature of 15° with a pressure drop equal to 2,5% every 10 mt.

Table D - Maximum delivery l/min. (standard reference atmosphere)

Real Pressure (bar)	Outside diameter (mm)					
	20	25	32	40	50	63
1	260	460	900	1600	2950	5400
3	660	1250	2400	4420	7950	15100
5	1200	2300	4100	7240	1300	24200
7	1650	2980	5660	10150	18300	33570
10	2415	4320	8190	14580	26540	48840
12	2900	5350	10220	18460	33570	61780

*ANR: Standard Reference Atmosphere

2.2 Fitting pressure drops

Although fittings are smooth inside and have the same tube inside diameter they nonetheless represent an obstacle to air flow, particularly when tubes change direction as in the case of bends, tee-unions and reducers.

Table E refers to fitting pressure drops in relation to equivalent metres of tube.

Table E - Equivalent tube lengths of the same diameter (m)

Tube outer diameter	Coupling and Union	Elbow 90°	Tee-union on a straight line	Tee-union on a line deviation	Simple reducer
20	0,15	0,40	0,15	0,85	0,25
25	0,20	0,50	0,15	1,05	0,70
32	0,25	0,60	0,20	1,35	0,40
40	0,30	0,80	0,25	1,70	0,40
50	0,40	0,95	0,35	2,15	1,35
63	0,50	1,25	2,70	1,70	0,75

2.3 Network dimensioning

Once the compressed air consumption (l/min.) and the sustainable pressure drop have been calculated you can refer to table D to identify the correct tube dimension.

After having examined the plant and considered the changes of direction as well as the presence of tee-unions and reducers you can then refer to table E to complete and correct previous evaluations.

TUBES FOR COMPRESSED AIR

DESCRIPTION	Code	A	B	Length
ALUMINIUM TUBE 	059.020.017	20	1,5	4 m
	059.025.022	25	1,5	4 m
	059.032.029	32	1,5	4 m
	059.040.037	40	1,5	4 m
	059.050.046	50	2	4 m
	059.063.059	63	2	4 m

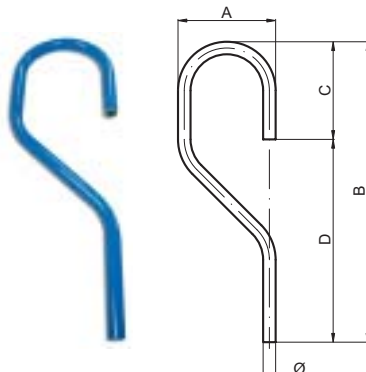



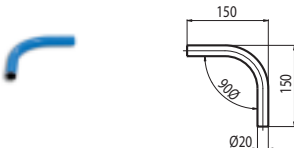
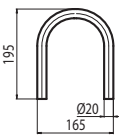
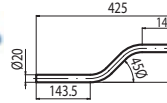
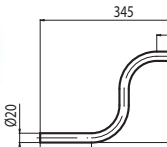



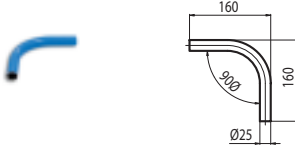
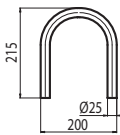
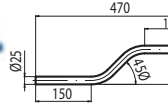
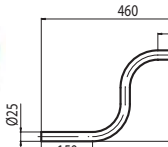

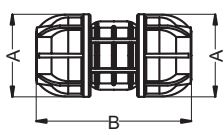
DESCRIPTION	Code	Ø	A	B	C	D
DROP BENDS 	059.015.100	15	110	435	102,5	332,5
	059.020.100	20	160	500	160	340
	059.022.100	22	160	550	155	395
	059.025.100	25	195	600	195	405

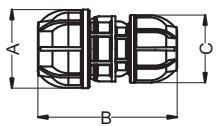

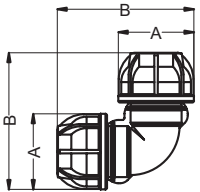

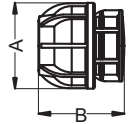

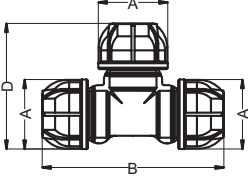

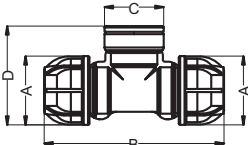
SPECIAL BENDS Ø 20

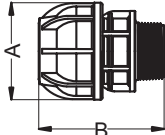

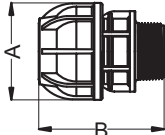

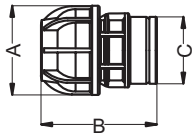
	Code
	059.020.101
	059.020.102
	059.020.103
	059.020.104

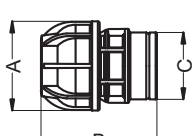
SPECIAL BENDS Ø 25

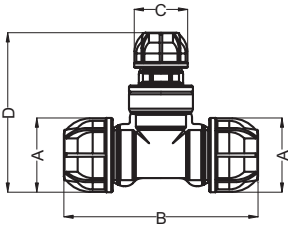

	Code
	059.025.101
	059.025.102
	059.025.103
	059.025.104

DESCRIPTION		Code	Ø	A	B	C	D
EQUAL UNION							
 	R210.020.020	20 x 20	44	85			
	R210.025.025	25 x 25	52	97			
	R210.032.032	32 x 32	62	113			
	R210.040.040	40 x 40	72	129			
	R210.050.050	50 x 50	86,50	157			
	R210.063.063	63 x 63	105	182			
REDUCING UNION							
 	R212.025.020	25 x 20	52	91	44		
	R212.032.025	32 x 25	62	103,50	52		
	R212.040.032	40 x 32	72	121	62		
	R212.050.040	50 x 40	86,50	145,50	72		
	R212.063.050	63 x 50	105	167	86,50		
90° EQUAL ELBOW							
 	R213.020.020	20 x 20	44	76			
	R213.025.025	25 x 25	52	92			
	R213.032.032	32 x 32	62	109			
	R213.040.040	40 x 40	72	127,50			
	R213.050.050	50 x 50	86,50	157,50			
R213.063.063	63 x 63	105	184				
END CAP							
 	R221.020.000	20	44	44,50			
	R221.025.000	25	52	53,50			
	R221.032.000	32	62	63			
	R221.040.000	40	72	68,50			
	R221.050.000	50	86,50	82,50			
R221.063.000	63	105	94,50				
EQUAL TEE							
 	R214.020.000	20 x 20 x 20	44	109,50		76,50	
	R214.025.000	25 x 25 x 25	52	132		93,50	
	R214.032.000	32 x 32 x 32	62	159,50		111	
	R214.040.000	40 x 40 x 40	72	182		127,50	
	R214.050.000	50 x 50 x 50	86,50	225		154	
	R214.063.000	63 x 63 x 63	105	262		182	
FEMALE TEE							
 	R215.025.012	25 x 1/2" x 25	52	132	30	75	
	R215.032.034	32 x 3/4" x 32	62	159,50	37	85	
	R215.040.001	40 x 1" x 40	72	182	43	103	
	R215.050.112	50 x 1 1/2" x 50	86,50	225	62	121	
	R215.063.002	63 x 2" x 63	105	262	77	148	

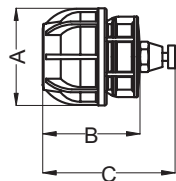
DESCRIPTION	Code	Ø	A	B	C
MALE STRAIGHT CONNECTION					
 	R211.020.012	20 x 1/2"	44	60	
	R211.025.012	25 x 1/2"	52	66,50	
	R211.025.034	25 x 3/4"	52	68	
	R211.032.001	32 x 1"	62	78,50	
	R211.040.001	40 x 1"	72	88,50	
	R211.040.114	40 x 1 1/4"	72	90	
	R211.050.112	50 x 1 1/2"	86,50	104	
	R211.063.002	63 x 2"	105	119	
ALUMINIUM MALE STRAIGHT CONNECTION					
 	R203.020.012	20 x 1/2"	44	60	
	R203.025.012	25 x 1/2"	52	66,50	
	R203.025.034	25 x 3/4"	52	68	
	R203.032.001	32 x 1"	62	78,50	
	R203.040.001	40 x 1"	72	88,50	
	R203.040.114	40 x 1 1/4"	72	90	
	R203.050.112	50 x 1 1/2"	86,50	104	
	R203.063.002	63 x 2"	105	119	
FEMALE STRAIGHT CONNECTION					
 	R201.020.012	20 x 1/2"	44	60,50	30
	R201.025.034	25 x 3/4"	52	69	37
	R201.032.001	32 x 1"	62	81	43
	R201.040.114	40 x 1 1/4"	72	92	54
	R201.050.112	50 x 1 1/2"	86,50	105	62
	R201.063.002	63 x 2"	105	122,5	77
ALUMINIUM FEMALE STRAIGHT CONNECTION					
 	R202.020.012	20 x 1/2"	44	60,50	30
	R202.025.034	25 x 3/4"	52	69	37
	R202.032.001	32 x 1"	62	81	43
	R202.040.114	40 x 1 1/4"	72	92	54
	R202.050.112	50 x 1 1/2"	86,50	105	62
	R202.063.002	63 x 2"	105	122,5	77
CONNECTION WITH JOINT IN 3 PIECE					
	R220.020.012	20 x 1/2"	44		
	R220.025.034	25 x 3/4"	52		
	R220.032.001	32 x 1"	62		
	R220.040.114	40 x 1 1/4"	72		
	R220.050.112	50 x 1 1/2"	86,50		
	R220.063.002	63 x 2"	105		

DESCRIPTION	Code	Ø	A	B	C	D
STRAIGHT CONNECTION WITH BALL VALVE 	R224.020.012	20 x 1/2"	44			
	R224.025.034	25 x 3/4"	52			
	R224.032.001	32 x 1"	62			
	R224.040.114	40 x 1 1/4"	72			
	R224.050.112	50 x 1 1/2"	86,5			
	R224.063.002	63 x 2"	105			
3 PIECE CONNECTION WITH BALL VALVE 	R225.020.012	20 x 1/2"	44			
	R225.025.034	25 x 3/4"	52			
	R225.032.001	32 x 1"	62			
	R225.040.114	40 x 1 1/4"	72			
	R225.050.112	50 x 1 1/2"	86,5			
	R225.063.002	63 x 2"	105			
REDUCING TEES CONNECTION  	R217.025.020	25-20-25	52	132	44	121
	R217.032.020	32-20-32	62	159,5	44	132
	R217.032.025	32-25-32	62	159,5	52	143
	R217.040.020	40-20-40	72	182	44	150
	R217.040.025	40-25-40	72	182	52	161
	R217.040.032	40-32-40	72	182	62	169
	R217.050.020	50-20-50	86,5	225	44	168
	R217.050.025	50-25-50	86,5	225	52	179
	R217.050.032	50-32-50	86,5	225	62	187
	R217.050.040	50-40-50	86,5	225	72	196
	R217.063.020	63-20-63	105	262	44	195
	R217.063.025	63-25-63	105	262	52	206
	R217.063.032	63-32-63	105	262	62	214
	R217.063.040	63-40-63	105	262	72	223
	R217.063.050	63-50-63	105	262	86,5	235
END CAPS WITH MANUAL VENT VALVE  	R218.020.014	20	44	44,5	64,5	
	R218.025.014	25	52	53,5	73,5	
	R218.032.014	32	62	63	83	
	R218.040.014	40	72	68,5	88,5	
	R218.050.014	50	86,50	82,5	102,5	
	R218.063.014	63	105	94,5	114,5	

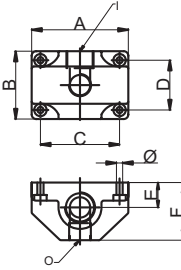
TERMINAL BLOCKS FOR COMPRESSED AIR (MAX 16 BARS)

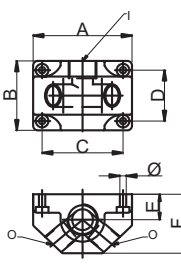
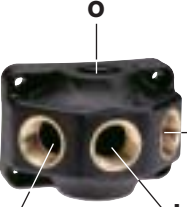
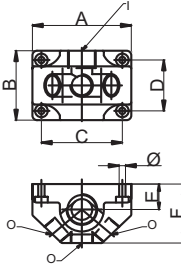
DESCRIPTION	Code	Use		Size		Drilling			Volume		
		I	O	A	B	C	D	Ø	E	F	
 	089.800.202	G 1/2"	G 1/2"	85,5	60	70	44	5,5	22	51	
	089.800.203	G 1/2"	G 3/4"	85,5	60	70	44	5,5	22	51	
 	089.800.204	2xG 1/2"	G 1/2"	85,5	60	70	44	5,5	22	51	
	089.800.205	2xG 1/2"	G 3/4"	85,5	60	70	44	5,5	22	51	
 	089.800.206	3xG 1/2"	G 1/2"	85,5	60	70	44	5,5	22	51	
	089.800.207	3xG 1/2"	G 3/4"	85,5	60	70	44	5,5	22	51	

TERMINAL BLOCKS FOR COMPRESSED AIR (MAX 16 BARS)



089.800.300





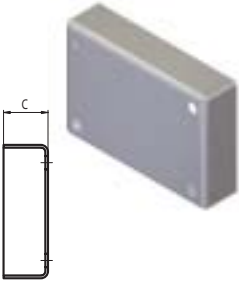
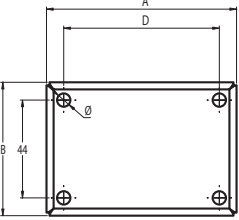



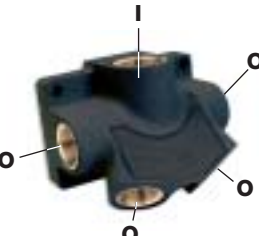
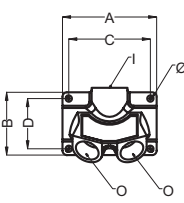
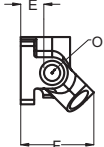

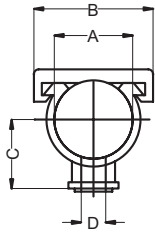

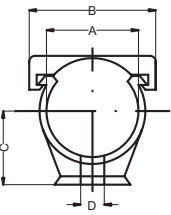

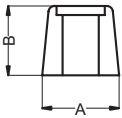
**Manual condensation drain
applicable on demand on the following models:
089 800 202 / 203 / 204 / 205 / 206 / 207**

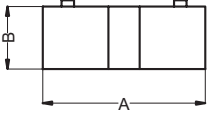
DESCRIPTION	Code	Use		Size		Drilling			Volume	
		I	O	A	B	C	D	Ø	E	F
SPACER FOR TERMINAL BLOCK										
										
										
	089.800.400			85,5	60	20	70	6	44	

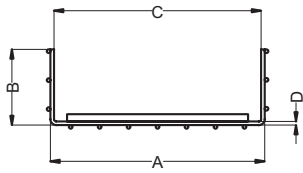
Spacer usable with the models: 089 800 202 / 203 / 204 / 205 / 206 / 207

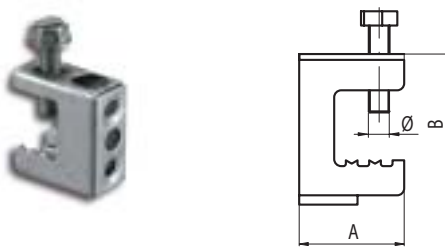
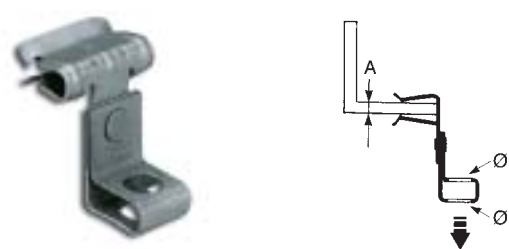
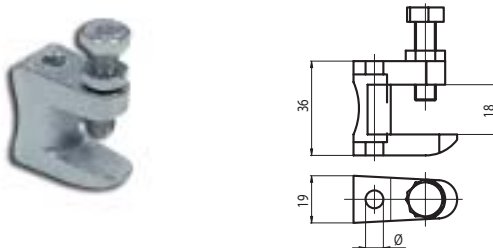
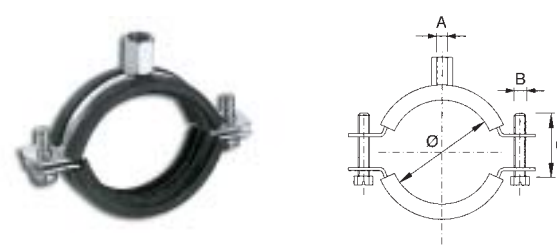

DESCRIPTION	Code	Use		Size		Drilling			Volume	
		I	O	A	B	C	D	Ø	E	F
										
										
										
	R231.012.012	G 1/2"	4 x 1/2"	105	70	91	56	7	35	81,5
	R231.034.012	G 3/4"	4 x 1/2"	105	70	91	56	7	35	81,5

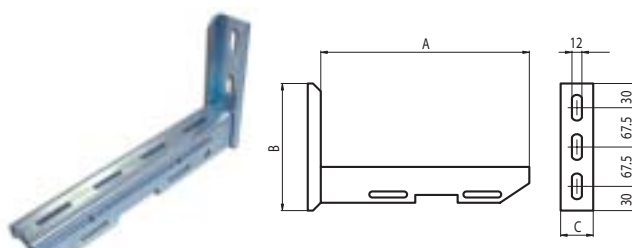
DESCRIPTION		Code	A	B	C	D
COLLAR  	HCKM6020	20	32	22	M6	
	HCKM6025	25	39	22	M6	
	HCK20/8	20	32	22	M8	
	HCK25/8	25	39	22	M8	
	HCKP020	20	32	22	Ø5,5	
	HCKP025	25	39	22	Ø5,5	
COLLAR  	HCKCM6032	32	45	28	M6	
	HCKCM6040	40	55	32	M6	
	HCKCM6050	50	68	36	M6	
	HCKCM6063	63	82	40	M6	
	HCKCM8032	32	45	28	M8	
	HCKCM8040	40	55	32	M8	
	HCKCM8050	50	68	36	M8	
	HCKCM8063	63	82	40	M8	
SPACER  	CALE1225	26	23			
SPACER  	CALE3263	52	20			
PIPE THROUGH (L=1965)  	090.305.000	306	104,5	286	5	
	090.505.000	546	104,5	526	5	
COUPLING KIT FOR PIPE THROUGH 	090.080.100					

DESCRIPTION	Code	Ø	A	B	C	D
<p>CLIP STIRRUP ON BEAMS</p> 	R230.000.001	M6	30	34		
<p>CLIP STIRRUP ON BEAMS</p> 	R233.000.001	11	3/8			
	R233.000.002	11	8/14			
	R233.000.003	11	14/20			
<p>CLIP STIRRUP ON BEAMS</p> 	R234.000.001	9				
	R234.000.002	M8				
<p>COLLAR FOR TUBE FIXATION</p> 	R230.020.000	20	M8/M10	M6	20	
	R230.025.000	25	M8/M10	M6	20	
	R230.032.000	32	M8/M10	M6	20	
	R230.040.000	40	M8/M10	M6	25	
	R230.050.000	50	M8/M10	M6	25	
	R230.063.000	63	M8/M10	M6	25	
<p>FIXING SCREWS</p> 	R230.000.002					
	M8 L=50					
<p>WALL MOUNTING BRACKET</p> 	R228.170.000		170	195	50	
	R228.320.000		320	195	50	
	R228.520.000		520	195	50	

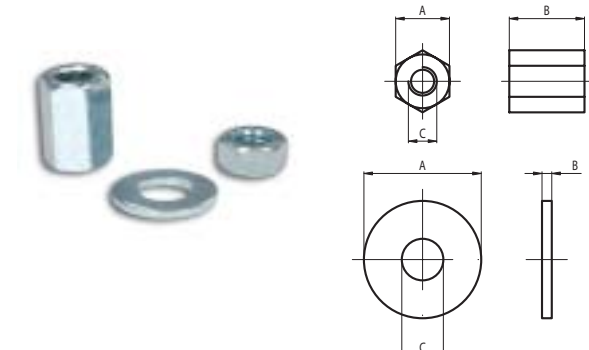
ACCESSORIES FOR THE ASSEMBLY

DESCRIPTION	Code	Ø	A	B	C	D	
PLATED IRON STUDDING M8 L=1000 GALVANISED  CONNECTION ACCESSORIES 	R230.000.006						
	R230.000.003		11	30	M8		
	R230.000.004		13	6,5	M8		
	R230.000.005		24	8,5	2		

DESCRIPTION	Code	Ø	A	Length
FLEXIBLE TUBE L. 500 mm  Tubes non-suitable for the compressor outlet connection.	R226.012.500	1/2"	1/2"	500
	R226.034.500	3/4"	3/4"	500
	R226.001.500	1"	1"	500
	R226.114.500	1 1/4"	1 1/4"	500
	R226.112.500	1 1/2"	1 1/2"	500
	R226.002.500	2"	2"	500
FLEXIBLE TUBES L. 1500 mm  Tubes non-suitable for the compressor outlet connection.	R227.012.150	1/2"	1/2"	1500
	R227.034.150	3/4"	3/4"	1500
	R227.001.150	1"	1"	1500
	R227.114.150	1 1/4"	1 1/4"	1500
	R227.112.150	1 1/2"	1 1/2"	1500
	R227.002.150	2"	2"	1500

DESCRIPTION	Code	Ø	A	Length
PRESSURISED TAP-IN TOOL	R208.012.040	1/2"	202	
	R208.001.063	1"	294	

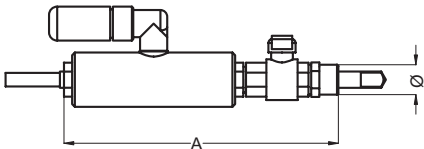

STRAP SPANNER 40-120 mm TIGHTENING

	Ø	Code
	40 to 120	R200.020.063

C SPANNER FOR COUPLING RINGS

	Ø Coupling ring	Code
	20	R200.035.050
	25-32-40	R200.050.080
	50-63	R200.080.120

DEBURRING CONE UP TO Ø 50 for the external bevelling and the internal shaving of tubes up to Ø 50 mm

	up to Ø 50	Code
		CONE050

ADJUSTABLE REAMER for tubes from 50 to 160

	Ø	Code
	50 to 63	TEMPE50315

DEBURRING TOOL

	Ø	Code
	All	R230.000.007

TUBE CUTTER with deburring tool

	Ø	Code
	12 to 35	CT1240
	12 to 63	CT1263

DESCRIPTION

HOSE REEL

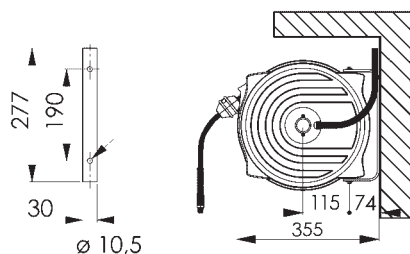

R222.015.000 / R222.012.000

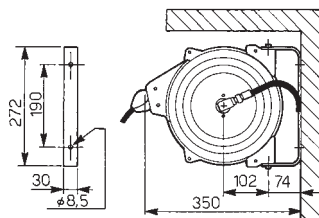

R122.012.000 / R122.010.000

Code	Ø Connection	Ø Tube	L m
R122.012.000	1/4"	8x12	12
R122.010.000	1/4"	10x14	10
R222.015.000	1/4"	8x12	15
R222.012.000	1/4"	10x14	12



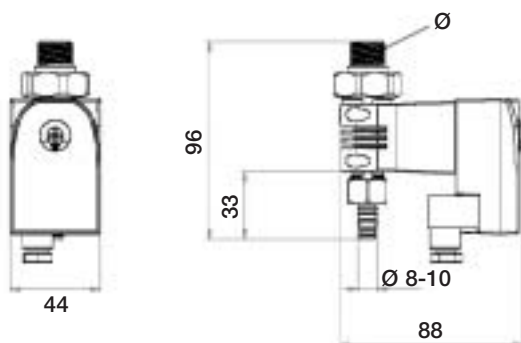

DESCRIPTION

AUTOMATIC CONDENSATE DRAIN



44

Code	Connection	Electrically pilot
R223.014.000	1/4"	220 V CA

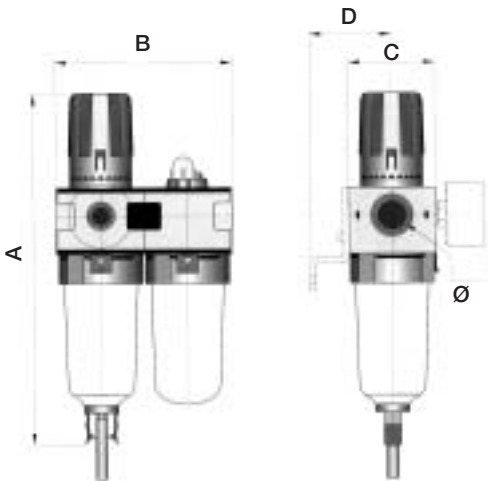
DESCRIPTION	Code	Ø	A	B	C	D	
AIR PREPARATION UNIT							
	R224.012.000	1/2"	253	127	62	58	
	R224.038.000	3/8"	185	95	50	52,5	
							
							
							

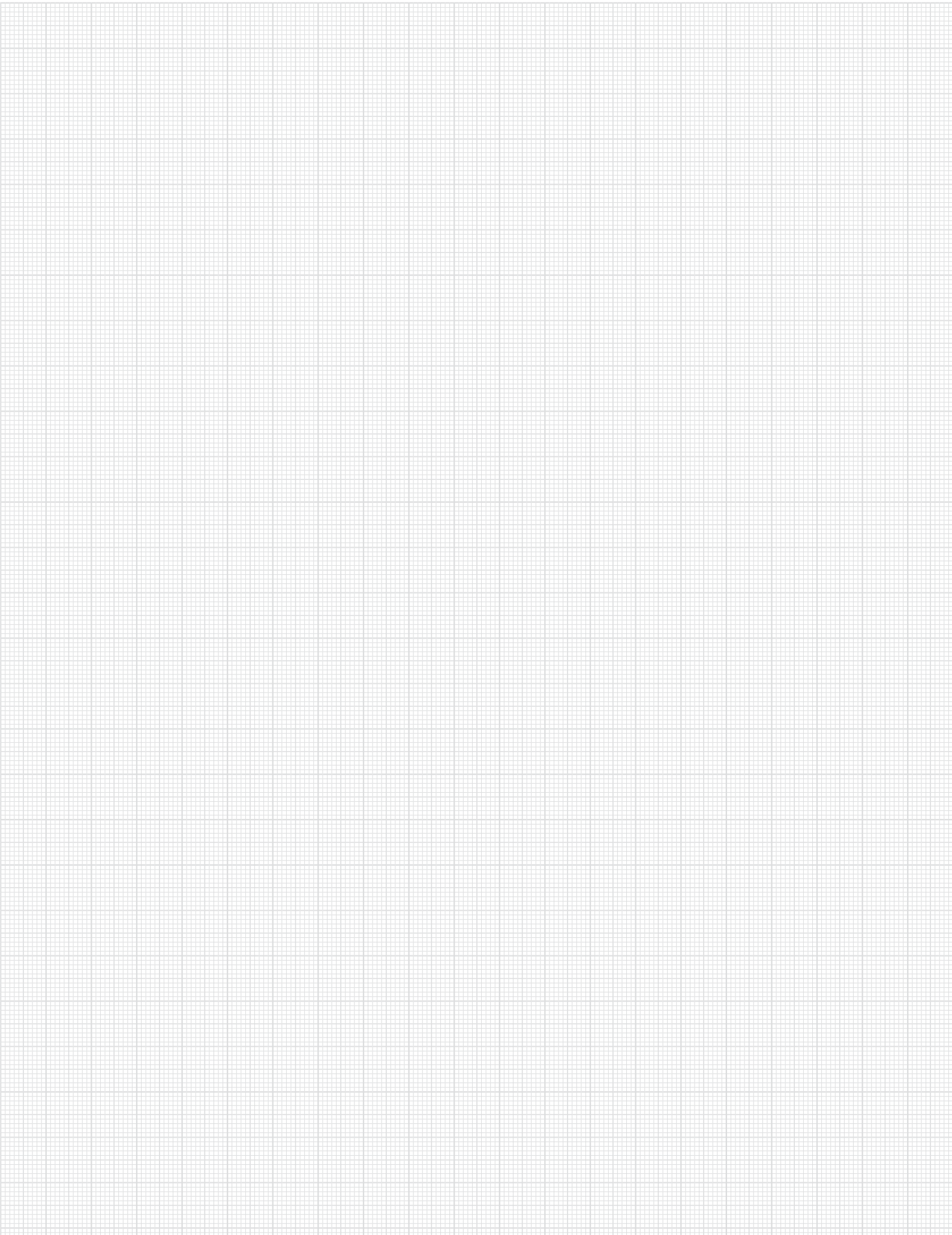

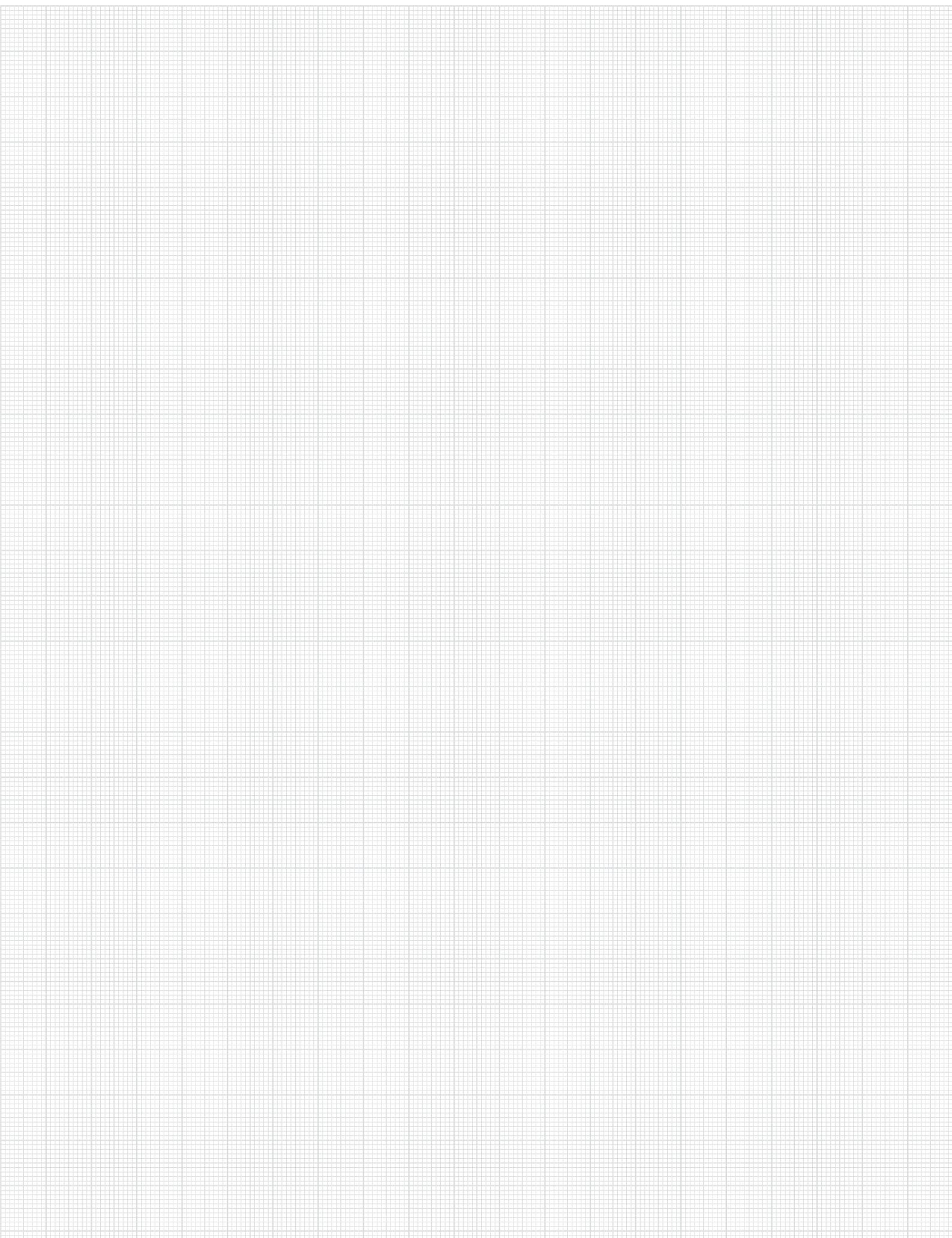



Sicomat®

via Bologna, 10/D - MONDOVÌ (Cn)
Tel. 0174 47.780 - Fax 0174 47.975

sicomat@sicomatsas.it www.sicomatsas.it